

Инструкция по сборке Instructions for assembling furniture Instrukcja montażu mebli

Набор мебели для общей комнаты
Collection «OLIVIA»
Kolekcja mebli

Шкаф 4D2S
Szafa 4D2S
Cupboard 4D2S

AH-021.46.00.00

Шкаф 4D2S Z
Szafa 4D2S Z
Cupboard 4D2S Z
AH-021.47.00.00

Элементы для докупки
Dodtkowe elementy do zakupu
Additional elements for buy

Фасад 167 P
Front 167 P
Front 167 P

Фасад 167 PL
Front 167 PL
Front 167 PL

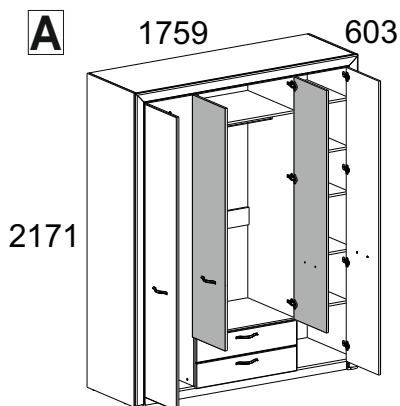

Фасад 167 Z
Front 167 Z
Front 167 Z

Фасад 167 ZL
Front 167 ZL
Front 167 ZL

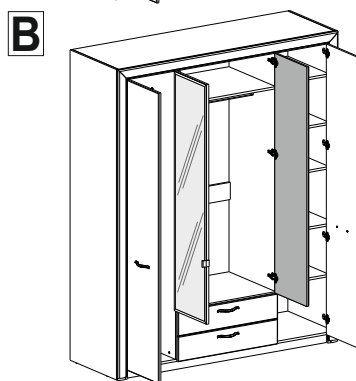

Дата изготовления
Production date
Data produkcji

Штамп ОТК
Stamp of Quality Department
Pieczęć Działu Jakości

ИООО « АНРЭКС »

Республика Беларусь, 224004
г.Брест, ул. Катин Бор, 119
тел/факс (+375162) 30-17-07



ЕАЭС № BY/112 11.01. TP025 018.01 01143
от 17.08.2022
по 16.08.2027

Инструкция по эксплуатации.

Качество и комплектность изделия рекомендуется проверять в магазине при покупке в распакованном виде. Сборка изделия должна производиться в порядке, изложенном в настоящей инструкции. В процессе эксплуатации изделий необходимо периодически затягивать ослабленные винтовые соединения. В случае необходимости перемещения изделия по квартире перед его перестановкой, необходимо полностью освободить его от груза (матраца). Во избежание поломок имеющих опор передвигание производить приподнимая изделие над уровнем пола. Запрещён прямой контакт с водой. Удаление пыли с изделий следует производить слегка влажной мягкой салфеткой. Во избежание коробления деталей и изменения цвета изделия следует избегать установки мебели на прямых солнечных лучах.

При эксплуатации изделий набора **ЗАПРЕЩАЕТСЯ:**

- устанавливать мебель вблизи отопительных приборов и вплотную к сырým стенам и в помещениях с относительной влажностью более 70%;
- температура нагрева элементов мебели не должна превышать +40 °С.
- в процессе сборки и эксплуатации изделий набора становиться ногами на горизонтальные щиты и витрины;
- применять химические чистящие средства для уборки мебели;

Гарантии изготовителя.

1. Гарантийный срок эксплуатации изделия - 24 месяца со дня продажи магазином. В период гарантийного срока изготовитель гарантирует ремонт изделий или их замену, если потребителем не нарушены правила эксплуатации.
2. Претензии предъявляются потребителем непосредственно в торгующую организацию, в которой была приобретена мебель, предъявив настоящую "Инструкцию по сборке" и копию товарного чека.
3. Изделия **Шкаф 4D2S, Шкаф 4D2S Z**, входящие в состав набора мебели для общей комнаты **«OLIVIA»**, соответствуют требованиям ГОСТ 16371-2014, ТР ТС 025/2012.
4. Срок службы мебели - 5 лет.
5. Предприятие-изготовитель оставляет за собой право вносить изменения в конструкцию изделия, не ухудшая его конструктивные и эксплуатационные характеристики.
6. Для сборки изделий рекомендуется привлекать квалифицированных специалистов.

Запах.

От новой мебели может исходить запах материалов, из которых она изготовлена. Запах может сохраняться в течение трёх недель с момента сборки. Для снижения интенсивности запаха рекомендуется:

- для мягкой мебели - пропылесосить изделие и проветрить помещение.

Повторять 3-4 раза в день.

- для корпусной мебели – протирать тканью, смоченной мягким моющим средством, вытирать чистой сухой тканью и проветривать помещение, предварительно открывая все двери и ящики изделия.

Повторять 3-4 раза в день.

Важно! Сохраните, пожалуйста, инструкцию в случае повторной сборки мебели или рекламации. В случае составления рекламации пользуйтесь, пожалуйста, обозначением из инструкции сборки.

PL**Przy eksploatacji mebli zabrania się:**

- ustawiać meble w pobliżu grzewczych przyrządów i obok wilgotnych ścian, a także w pomieszczeniach ze względną wilgotnością więcej niż 70%;
- temperatura nagrzewania elementów mebli nie może przekraczać +40°C;
- w trakcie montażu i eksploatacji mebli stawać nogami na poziome panele i witryny;
- stosować chemiczne środki czyszczące do sprzątania mebli;
- nie należy narażać na kontakt z wodą.

Gwarancje producenta.

1. Gwarancyjny termin eksploatacji wyrobu - 24 miesiące z dnia sprzedaży. W okresie gwarancyjnego terminu producent gwarantuje naprawę wyrobów lub ich zamianę, jeżeli reguły eksploatacji nie zostały naruszone przez nabywcę.
2. Roszczenia są przekazywane przez nabywcę bezpośrednio do handlującej organizacji, w której były nabyte meble, tylko przy okazaniu danej "Instrukcji montażu" wraz z dokumentem zakupu.
3. Wyroby **Szafa 4D2S, Szafa 4D2S Z**, wchodzące w zestaw mebli „**OLIVIA**”, odpowiada wymaganiom Norm Państwowych 16371-2014, TP TC 025/2012
4. Trwałość użytkowa mebli - 5 lat.
5. Firma-producent pozostawia za sobą prawo do wprowadzania zmian w konstrukcje wyrobów, nie pogarszając ich konstruktywne i eksploatacyjne charakterystyki.
6. Do montażu wyrobów zaleca się skorzystanie z pomocy wykwalifikowanych specjalistów.

Zapach.

Nowe meble mogą wydzielać zapach materiałów, z których są wykonane. Zapach może utrzymywać się do trzech tygodni od momentu montażu. Aby zmniejszyć intensywność zapachu, zaleca się:

- w przypadku mebli tapicerowanych - odkurzyć produkt i przewietrzyć pomieszczenie. Powtarzaj 3-4 razy dziennie.
- dla mebli szafkowych - przetrzyj ściereczką zwilżoną łagodnym detergentem, przetrzyj czystą, suchą ściereczką i przewietrz pomieszczenie, uprzednio otwierając wszystkie drzwi i szuflady produktu. Powtarzaj 3-4 razy dziennie.

Ważne! Proszę zachować instrukcję w razie ponownego montażu mebli lub reklamacji. Podczas składania reklamacji prosimy o korzystanie z oznaczeń z instrukcji.

EN**Instruction manual.**

It is advised to check the quality and completeness of the product in the store when buying unpacked. Assembling of the product should be done the way it's described in this manual. While the product is in service loose screw connections should be periodically tightened. If it's necessary to move items around the apartment before moving you should release the product completely from the load (the mattress). To prevent damage to existing supports the product should be lifted before moving. Furniture should not be exposed to contact with water. Dusting the product should be done with a slightly damp soft cloth. To prevent warping of parts and discoloration of products do not install furniture in direct sunlight.

While the product is in service it's PROHIBITED TO:

- Install furniture near heating devices, close to the raw walls and in rooms with a relative humidity of more than 70%;
- heat elements of furniture to the temperature higher +40°C;
- step on the horizontal shields and windows during assembly and use of the products set;
- use chemical cleaners for cleaning furniture;

Manufacturer's warranty.

1. The warranty period of use of the product - 24 months from the date of sale. During the warranty period the manufacturer guarantees repair or replacement of products, if the user has not violated operating rules.
2. Claims should be made by the consumer directly to the trading organization, in which furniture was purchased, presenting the "Instruction manual" and a copy of the sales receipt.
3. The products **Cupboard 4D2S, Cupboard 4D2S Z**, which are part of a set of "**OLIVIA**", meet the requirements of GOST 16371-2014, TR TS 025/2012.
4. The lifetime of furniture - 5 years.
5. The manufacturer reserves the right to make changes in product design, without compromising its design and application requirements.
6. To assemble the products it's recommended to attract qualified personnel.

Smell.

New furniture may emit the smell of the materials from which it is made. The smell can persist for up to three weeks from the time of assembly. To reduce odor intensity, it is recommended:

- for upholstered furniture - vacuum the product and ventilate the room. Repeat 3-4 times a day.
- for cabinet furniture - wipe with a cloth dampened in a mild detergent, wipe with a clean, dry cloth and ventilate the room, previously opening all doors and drawers of the product. Repeat 3-4 times a day.

It is important! Keep the instruction in case of reassembly of furniture or complaint. When making a claim use the notation from the instruction.

№ эл-та	Длина мм.	Ширина мм.	Толщина мм.	Кол-во шт.	№ пачки
1	1724	575	16	1	2/6
2	1724	575	16	1	2/6
3	452	510	16	4	1/6
4	454	575	16	1	1/6
5	1724	55	16	2	2/6
6	2166	575	16	1	4/6
7	2166	575	16	1	4/6
8	2152	80	25	1	6/6
9	2152	80	25	1	6/6
10	784	575	16	2	2/6
11	396	2028	18	1	3/6
12	396	2028	18	1	3/6
13	2079	575	16	1	5/6
14	2079	575	16	1	5/6
15	1759	80	25	1	6/6
16	500	100	18	2	1/6
17	500	100	18	2	1/6
18	722	100	18	2	2/6
19	796	175	18	2	2/6
20	784	120	16	1	2/6
23	756	506	2,5	2	2/6
24	2104	800	2,5	1	4/6
25	2104	475	2,5	2	5/6
Y2	777			1	2/6
Y2*	447			2	1/6

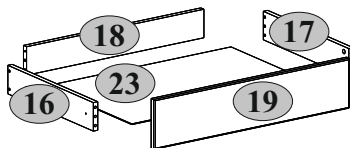
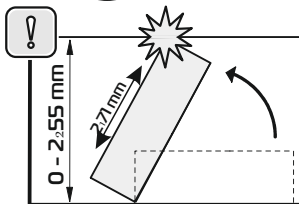
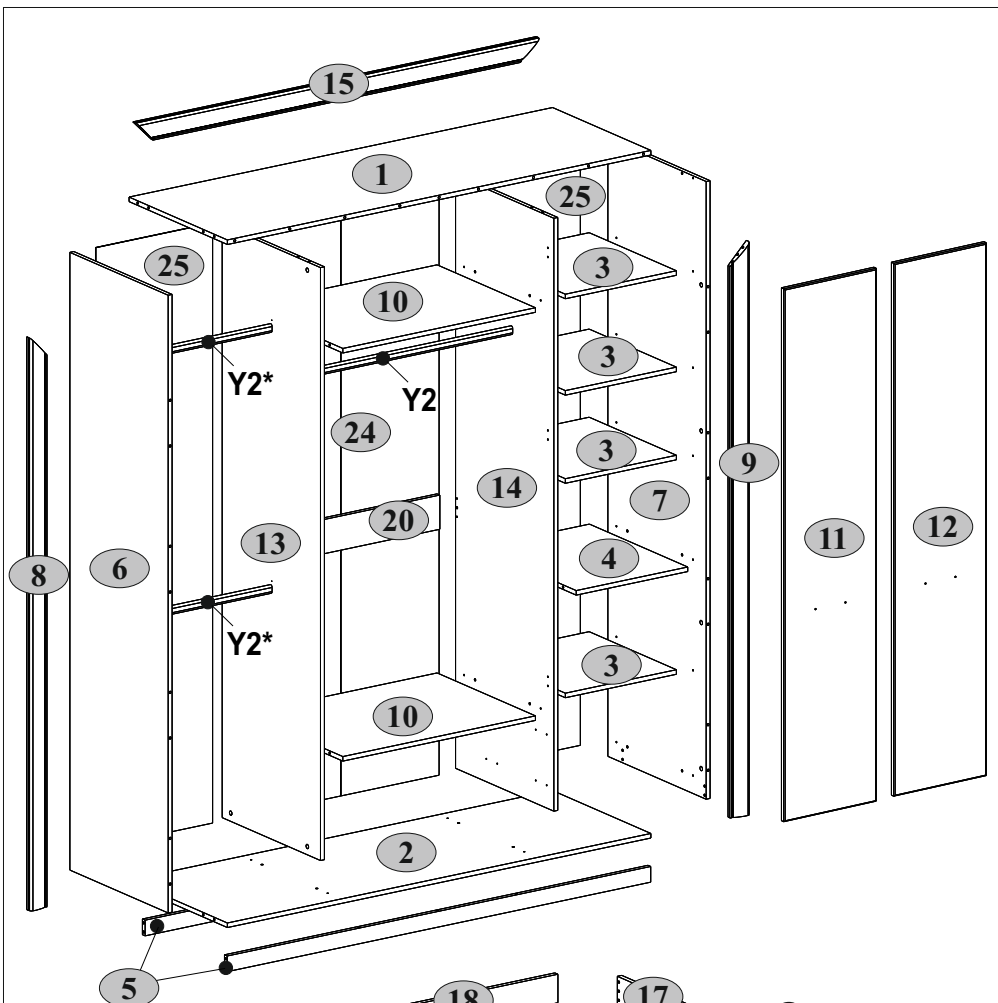

x2

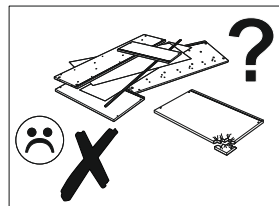
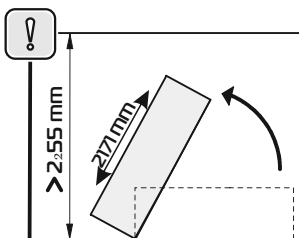

Элементы для докупки
Dodtkowe elementy do zakupu
Additional elements for buy

Фасад 167 P Front 167 P Front 167 P	№	Длина	Ширина	Толщина	Кол-во	№
	эл-та	мм.	мм.	мм.	шт.	пачки
	21	1672	396	18	1	1/1



Фасад 167 PL Front 167 PL Front 167 PL	№	Длина	Ширина	Толщина	Кол-во	№
	эл-та	мм.	мм.	мм.	шт.	пачки
	31	1672	396	18	1	1/1

Фасад 167 Z Front 167 Z Front 167 Z	№	Длина	Ширина	Толщина	Кол-во	№
	эл-та	мм.	мм.	мм.	шт.	пачки
	22	1672	396	22	1	1/1

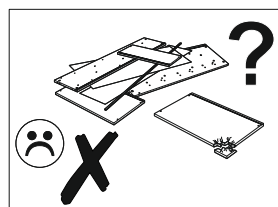
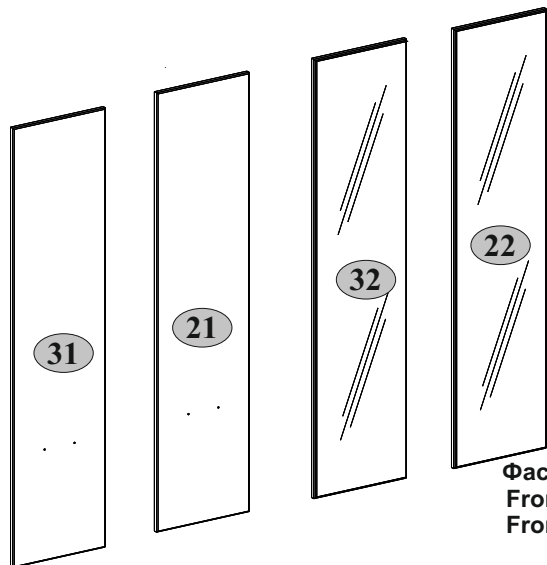

Фасад 167 ZL Front 167 ZL Front 167 ZL	№	Длина	Ширина	Толщина	Кол-во	№
	эл-та	мм.	мм.	мм.	шт.	пачки
	32	1672	396	22	1	1/1





Фасад 167 P
Front 167 P
Front 167 P

H19 	M12 
1	M4x25 2









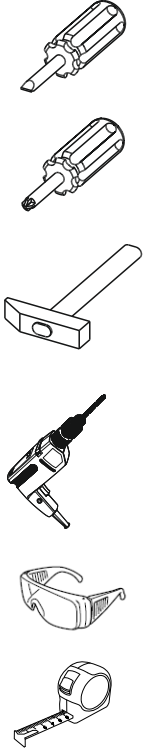



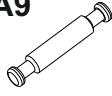
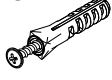
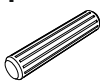













Фасад 167 ZL
Front 167 ZL
Front 167 ZL

H8 	R102 
1	3,5x16 2

Фасад 167 PL
Front 167 PL
Front 167 PL

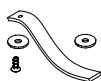
H19 	M12 
1	M4x25 2

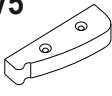

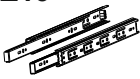
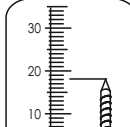
A1.0  5x28 54	A2  15x13 58	A9  L-47,4 2	B5  10x50 1
C1  8x35 67	D1  14	E2  8	E4  6
G  1,5x26 60	H19  4	I  S4 1	L2  500 2
M12  M4x25 8	N1  8	P1  Ø5 16	Q  1,5x7 12
R3  3x20 36	R5  3x30 4	R23  6,3x13 28	R24  7x50 8
R27  5,0x13 28	R102  3,5x16 48	S3  12	S5  Ø18 28
S6  1	S8-1  Ø20 8	V5  80x25x15 2	Y1  6
Z13  450 2			

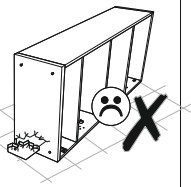
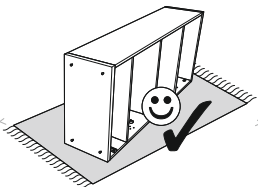
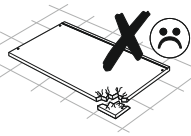
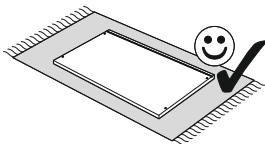
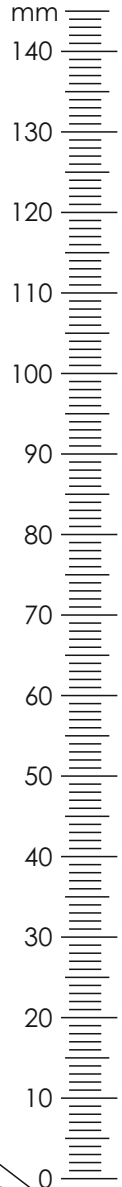

1

A1.0

5x28 6

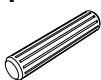
A2

15x13 4

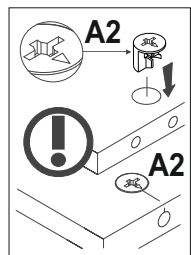
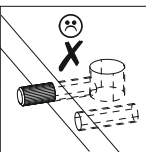
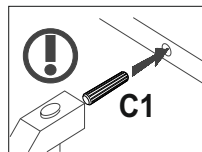
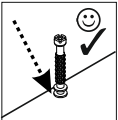
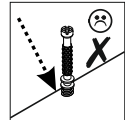
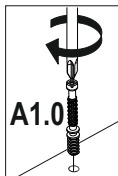
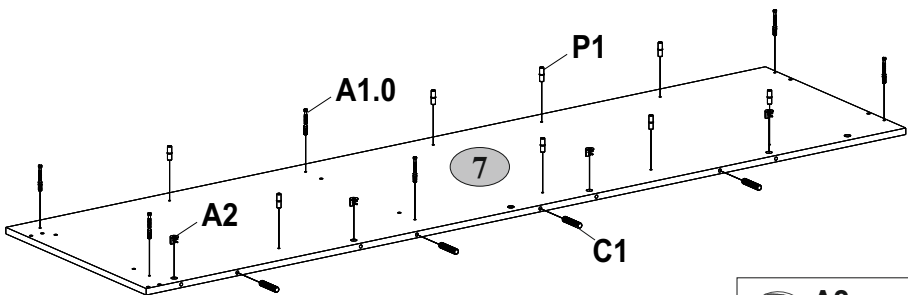
C1

8x35 4

P1

Ø5 8



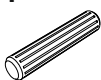

2

A1.0

5x28 4

A2

15x13 4

C1

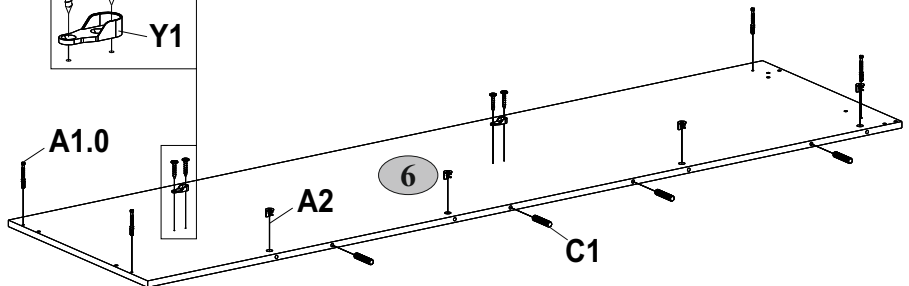
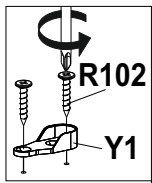
8x35 4

R102

3,5x16 4

Y1

2



3

A1.0



5x28

A2



8

15x13

C1

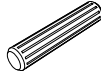

4

8x35

D1

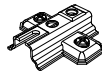

4

P1



3

Ø5

8

R23



6,3x13

R27



6

5,0x13

R102



8

3,5x16

Y1



2

Z13

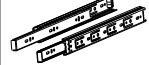

1

450

2

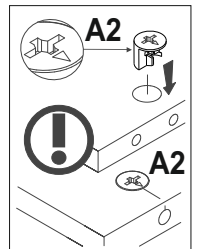
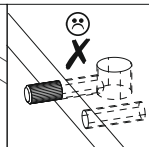
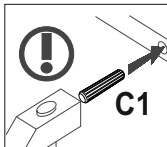
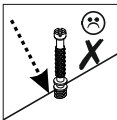
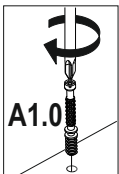
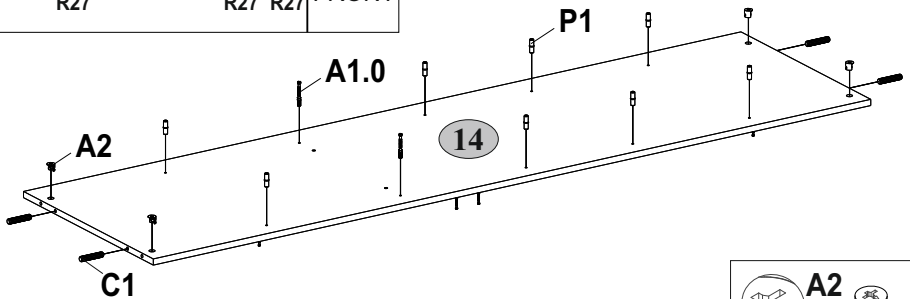
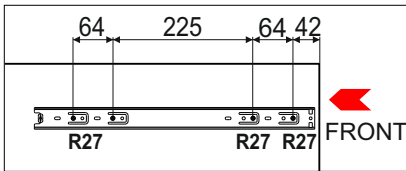
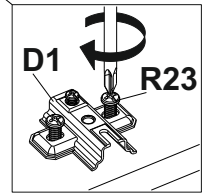
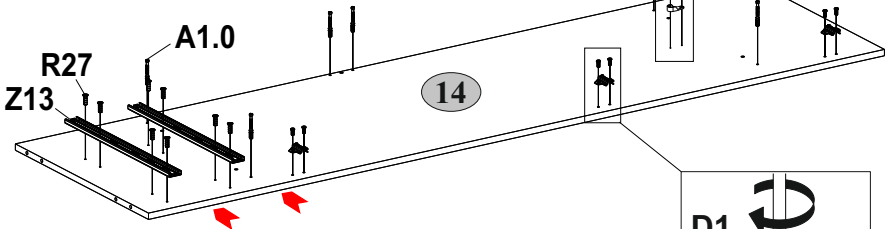
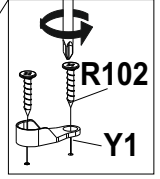
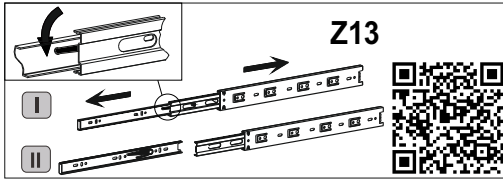

4

A1.0 5x28 6	A2 15x13 6	C1 8x35 4	D1 4	R23 6,3x13 6
R27 5,0x13 8	R102 3,5x16 6	Y1 3	Z13 450 2	

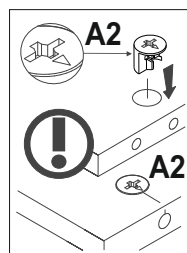
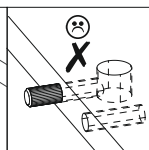
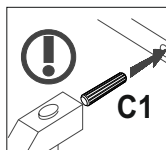
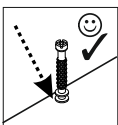
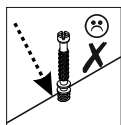
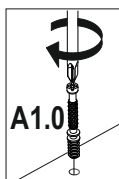
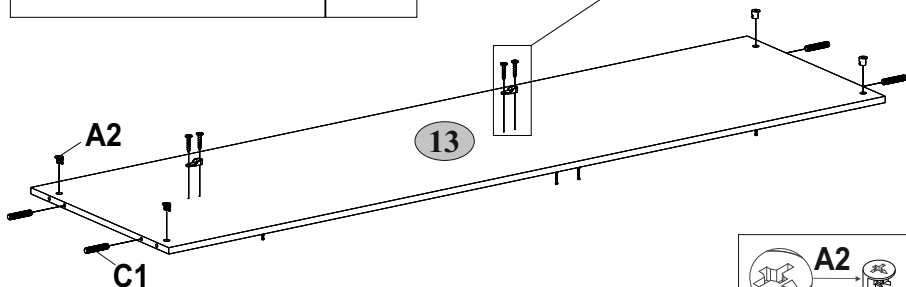
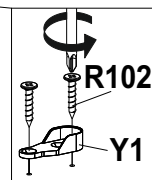
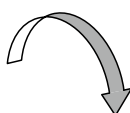
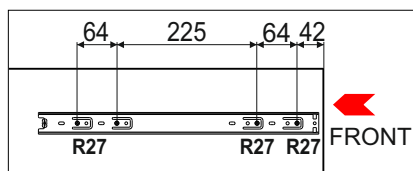
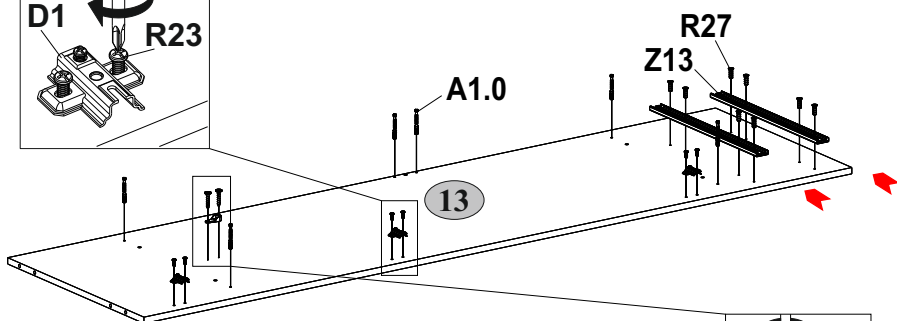
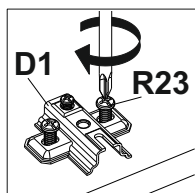

5

A1.0



5x28

A2



4 15x13

C1

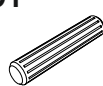

8 8x35

9

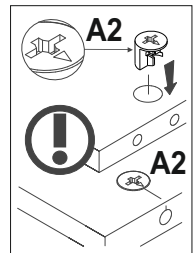
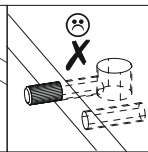
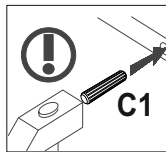
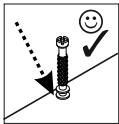
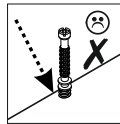
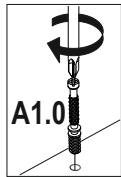
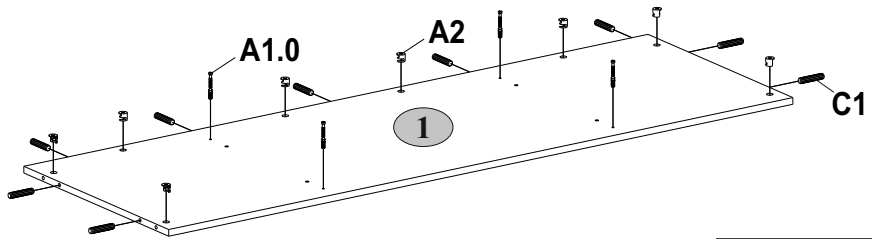

6

x2

A2



15x13

C1

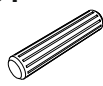

8 8x35

8

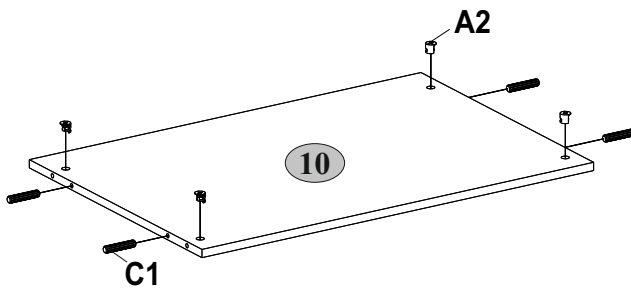

7

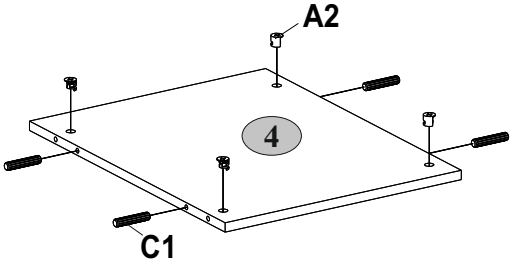
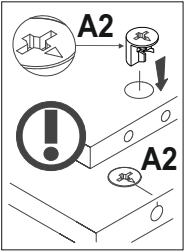
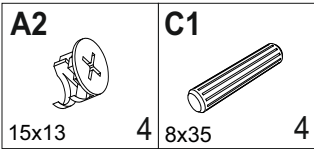

8

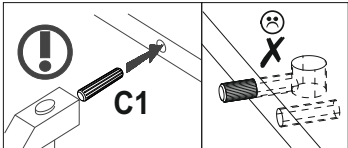
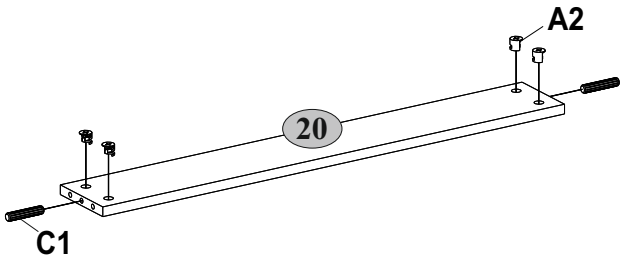
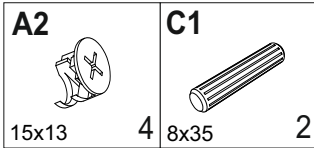

9

A1.0



5x28

A2



6 15x13

C1

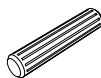

4 8x35

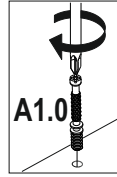

A1.0

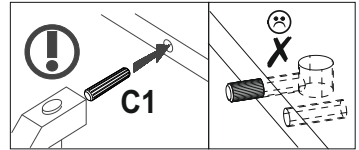
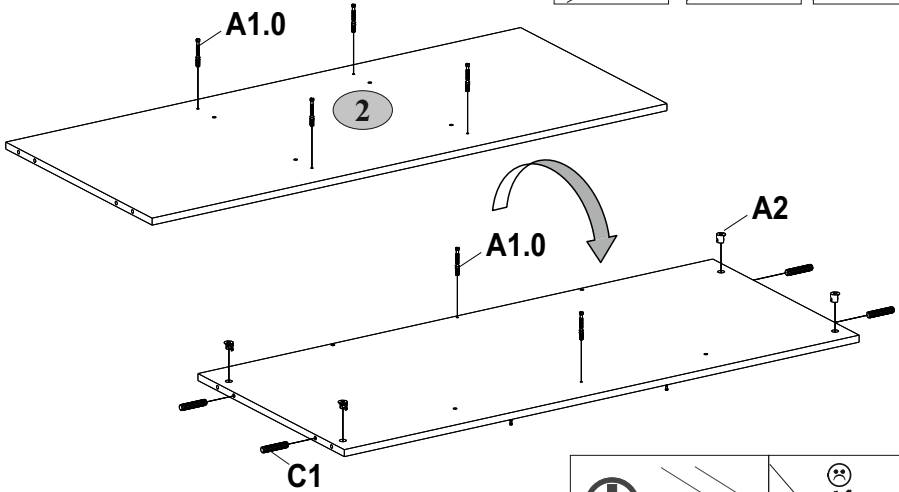
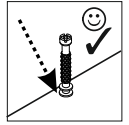
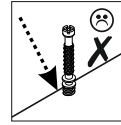

10

x2

A2



15x13

C1

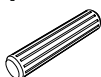

2 8x35 12

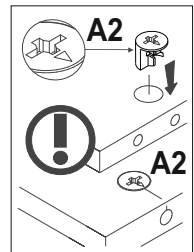
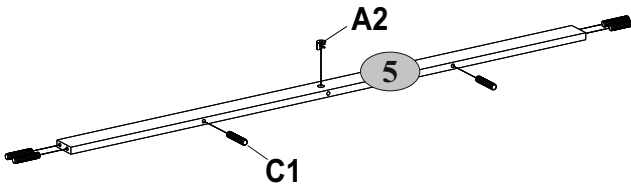

11

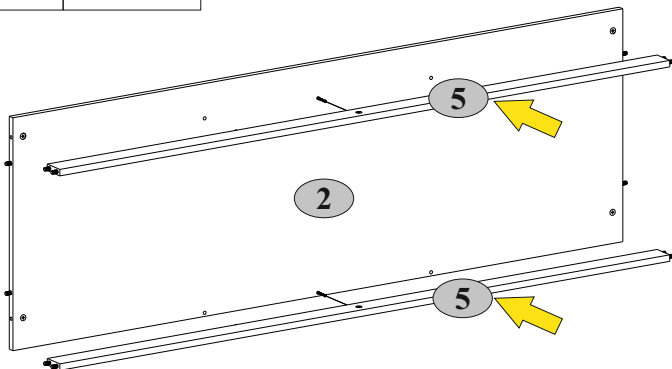
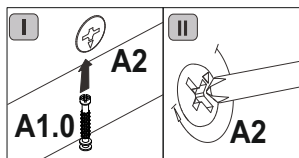

12

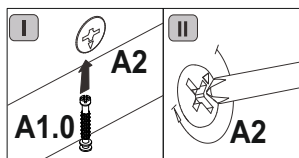
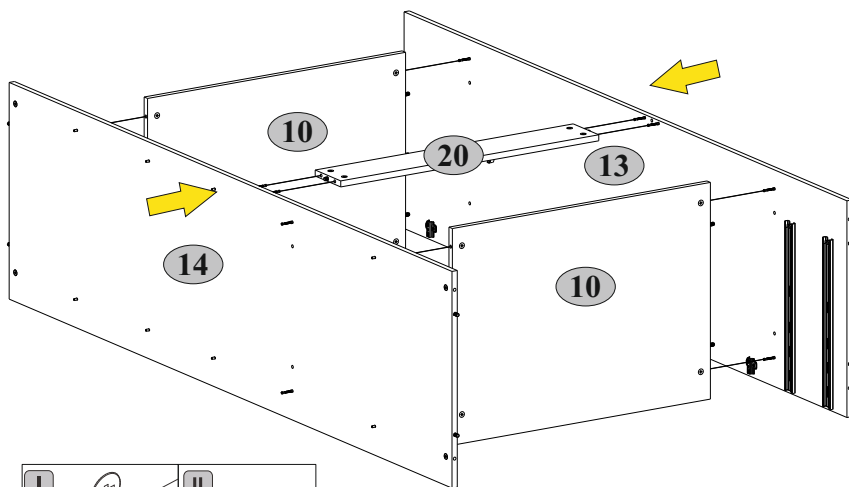



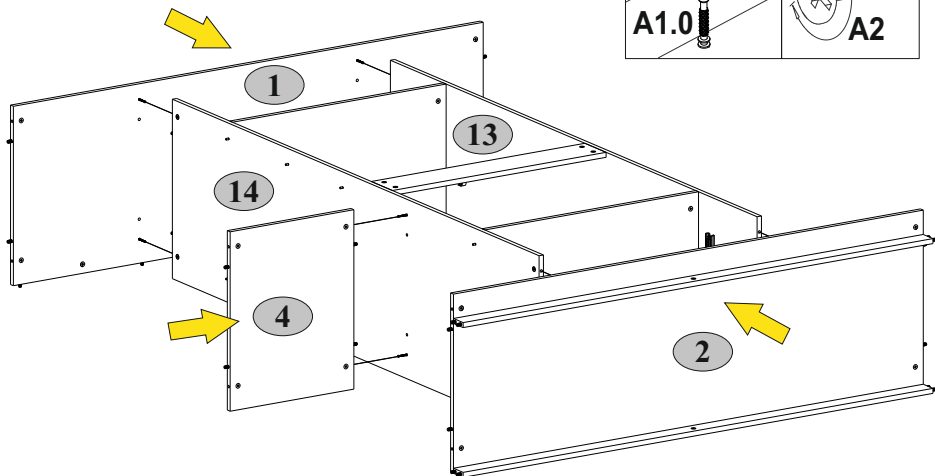

13

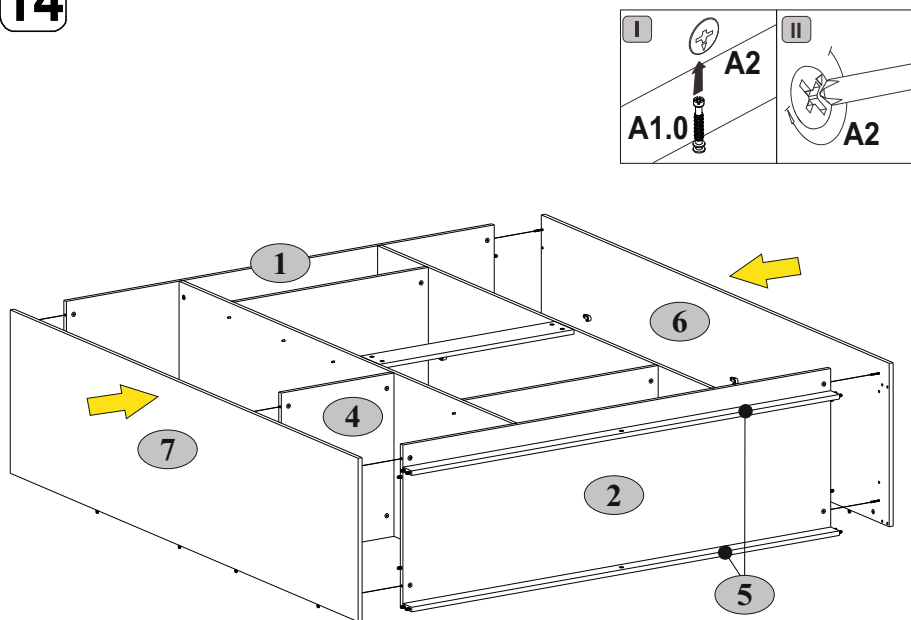

14

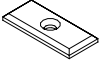

15

G  1,5x26 60	N1  8	R3  3x20 12	R102  3,5x16 4	S3  12
--	---	---	--	--

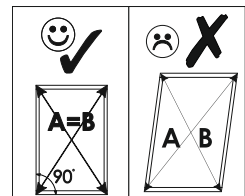
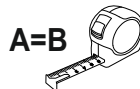
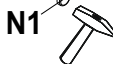
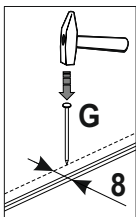
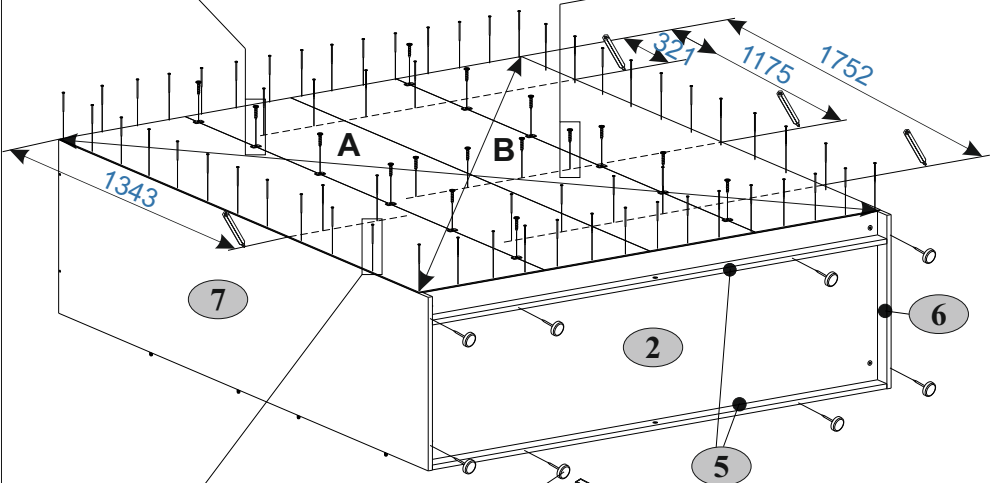
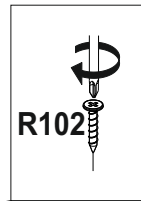
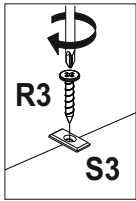
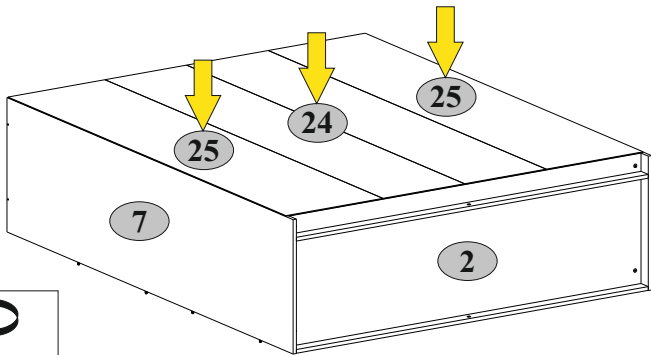

16**A1.0**

5x28

12

A2

15x13

4

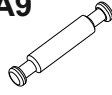
A9

L-47,4

C1

8x35

2

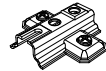
D1

4

8

R5

3x30

4

R23

6,3x13

16

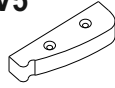
V5

80x25x15

2

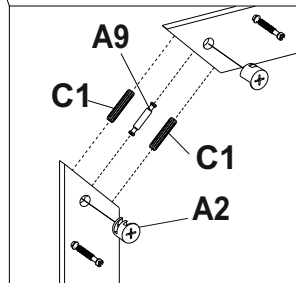
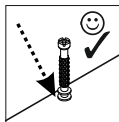
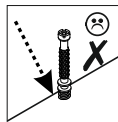
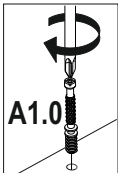
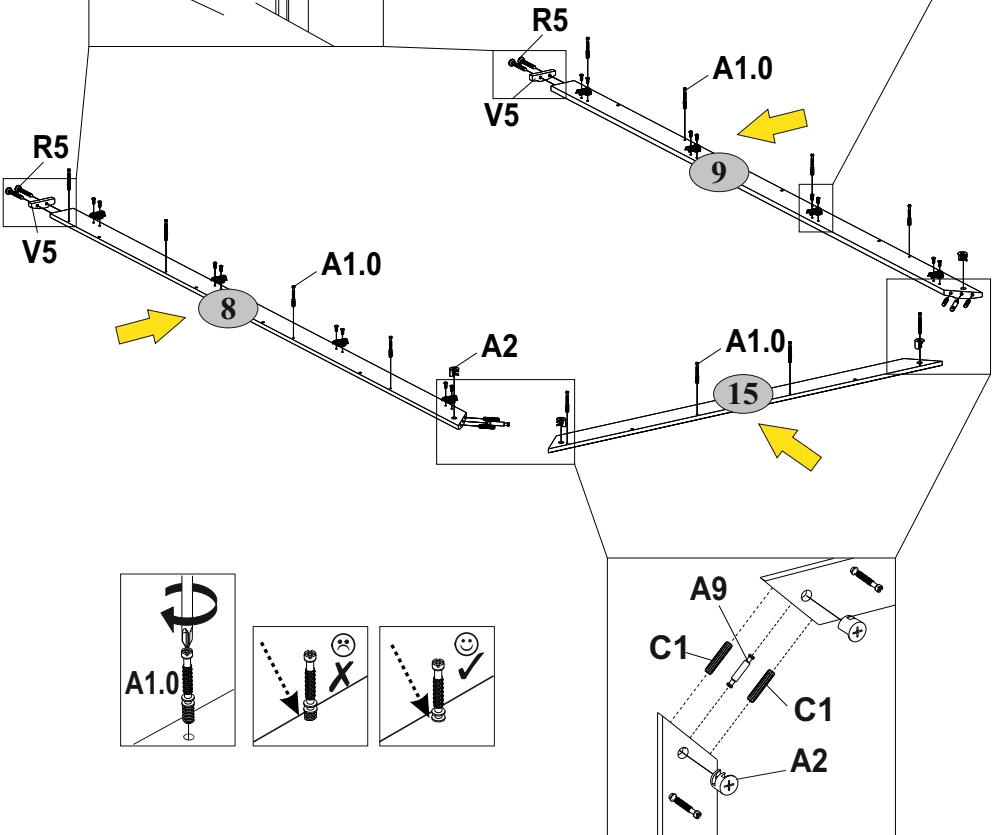
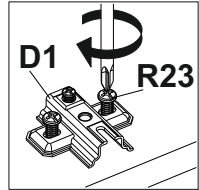
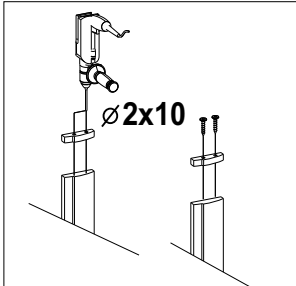

17

B5

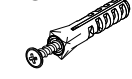

10x50

1

S6



1

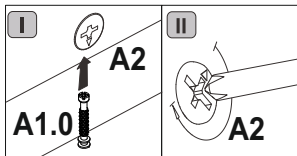
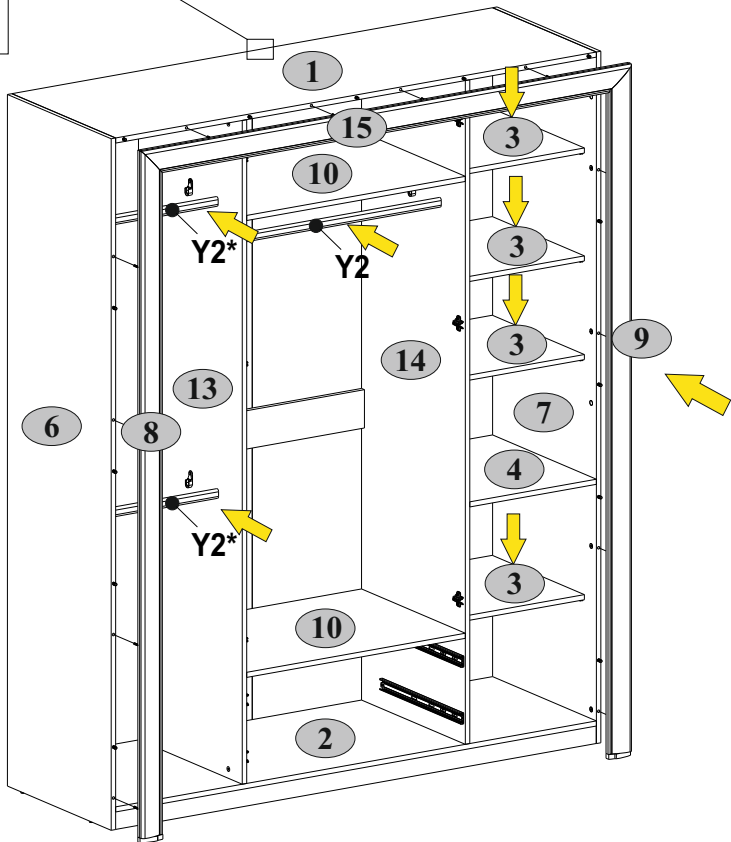
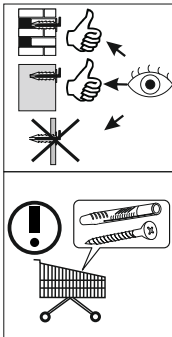
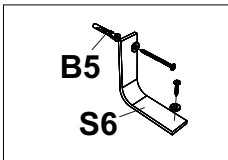
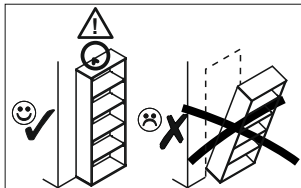

3

4

10

Y2*



max. 5 kg









2

Y2

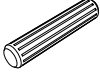

max. 15 kg

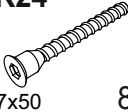
18**x2**

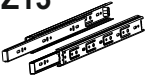
A1.0  5x28 8	A2  15x13 8	C1  8x35 8	H19  2
I  S4 1	M12  M4x25 4	R24  7x50 8	R27  5,0x13 12
Z13  450 2			

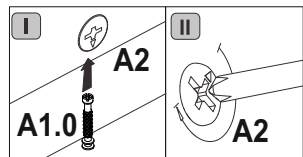
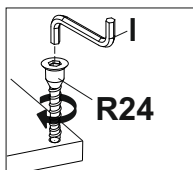
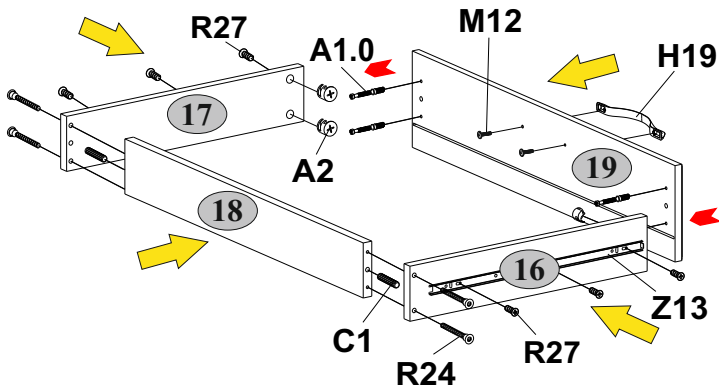
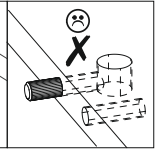
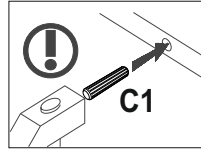
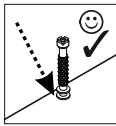
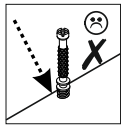
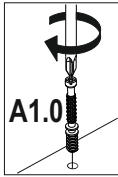
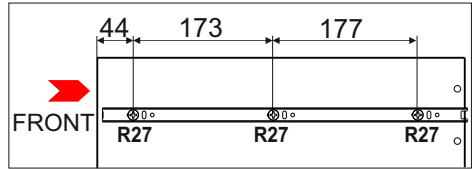
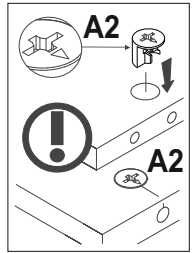

19
x2

L2



500

2

R3



3x20

24

R102



3,5x16

4

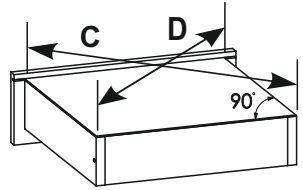

C=D

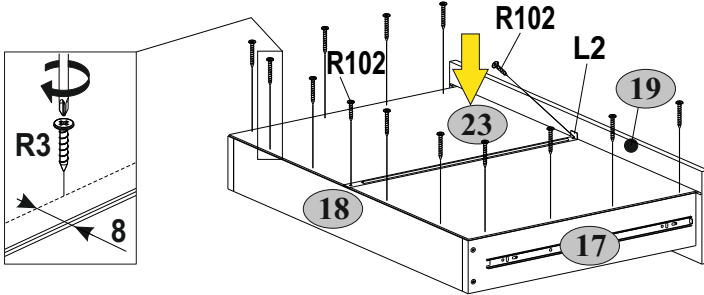
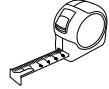

20

E2



8

R102



3,5x16

16

H19



2

M12



M4x25

4

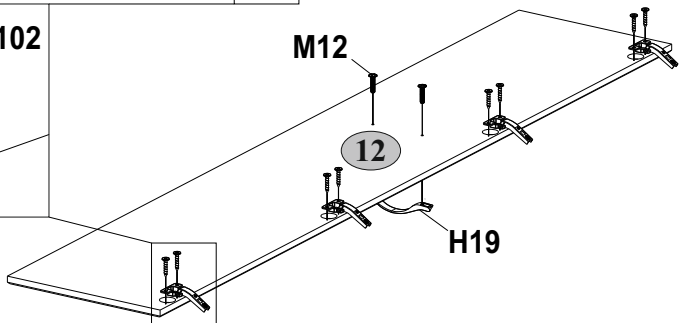
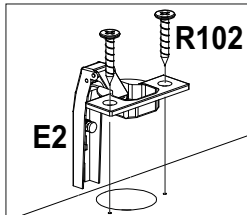
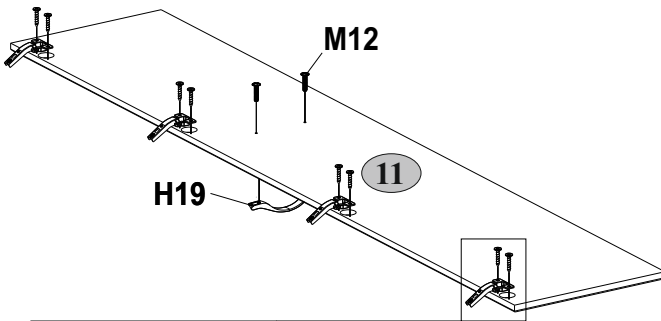

21**E4**

6

R102

3,5x16

12

H19

1

M12

M4x25

2

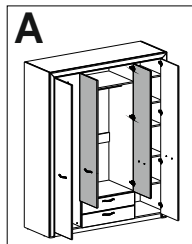
Фасад 167 P
Front 167 P
Front 167 P**A****H19**

1

M12

M4x25

2

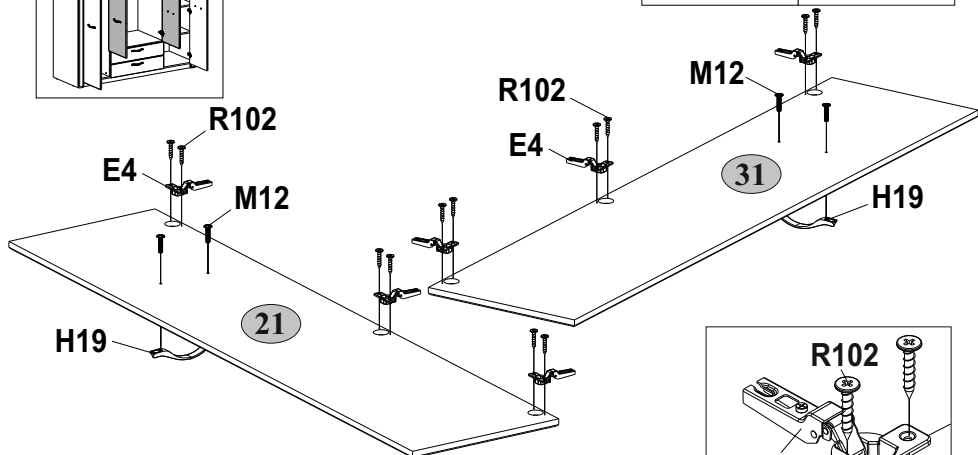
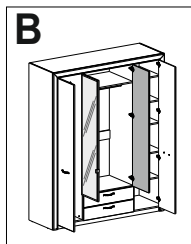
Фасад 167 PL
Front 167 PL
Front 167 PL**B****E4**
R102

22

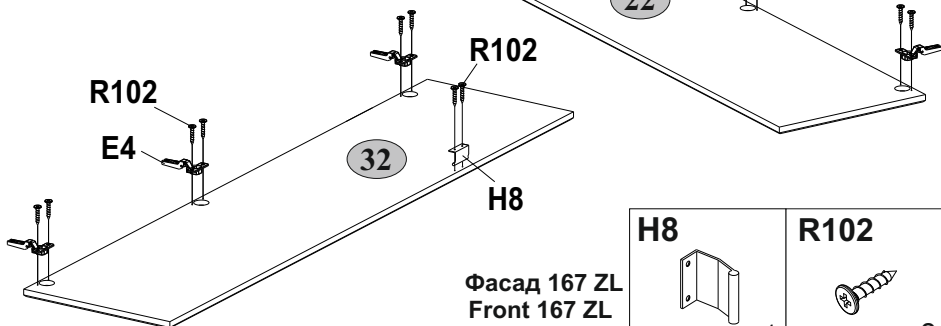
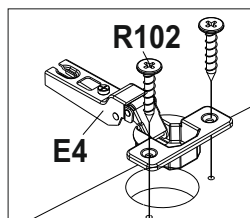
**H8**

1

R102

3,5x16

2

Фасад 167 ZL
Front 167 ZL
Front 167 ZL

22**Q**

1,5x7

S5

12 Ø18

S8-1

28 Ø20

8

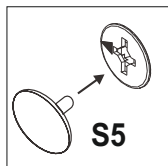
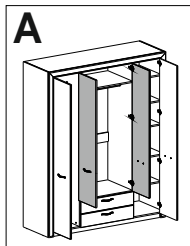
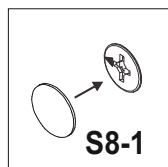
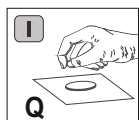
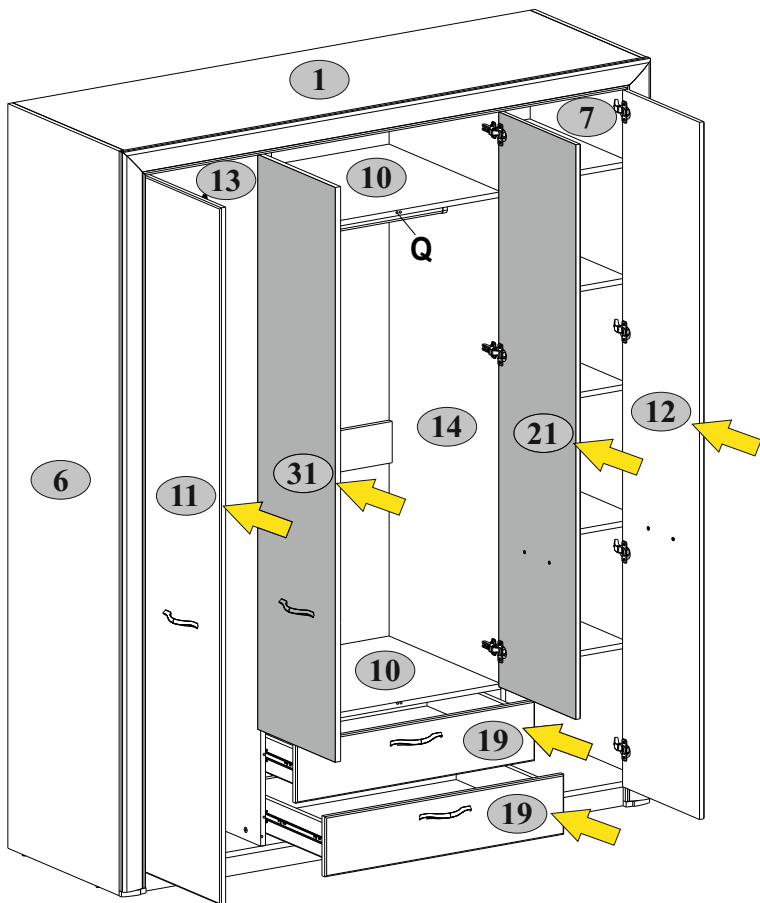
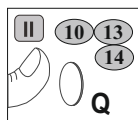
A**S5****S8-1****I****Q****II**

10 13 14

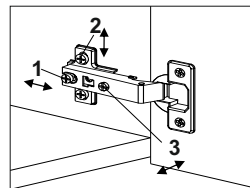
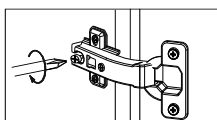
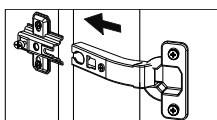
Q

1

2

3

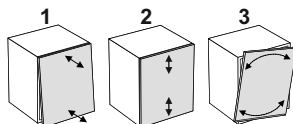
**19**max.
5 kg

22**Q**

1,5x7

S5

12 Ø18

S8-1

28 Ø20

8

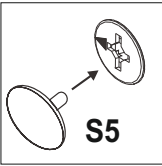
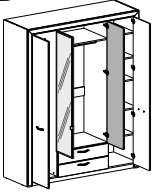
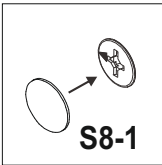
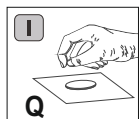
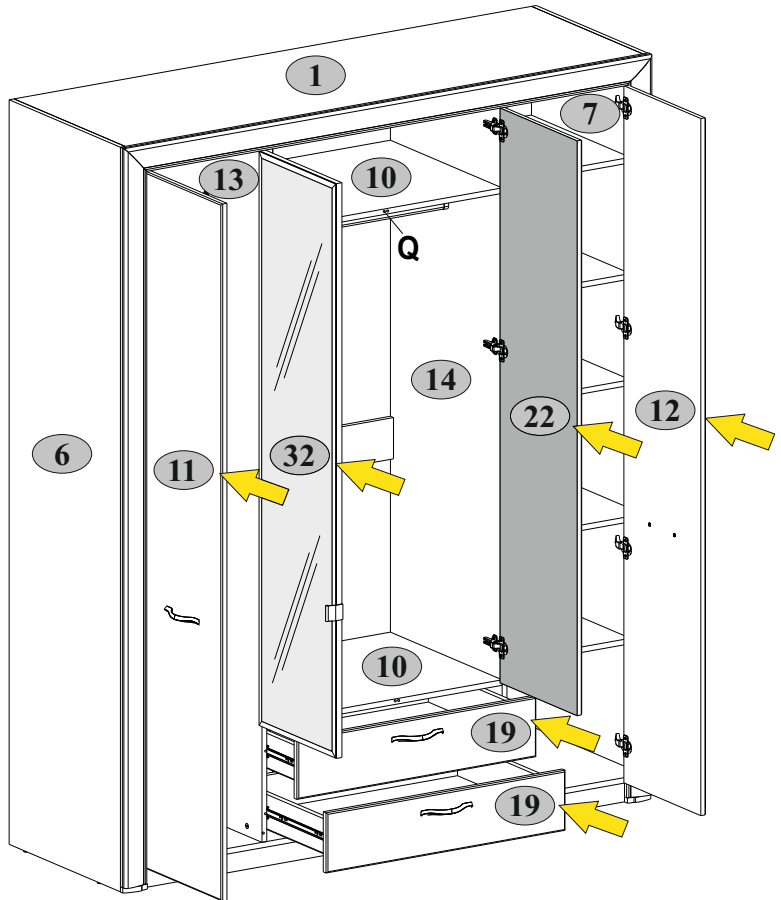
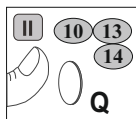
B**S5****S8-1****I****Q****II**

10

13

14

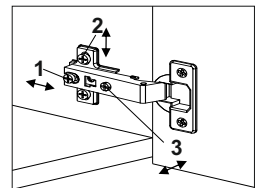
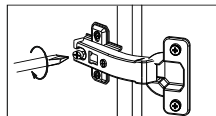
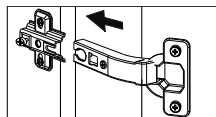
Q

1

2

3

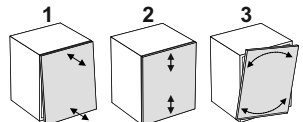
**19**max.
5 kg

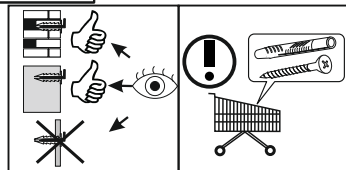
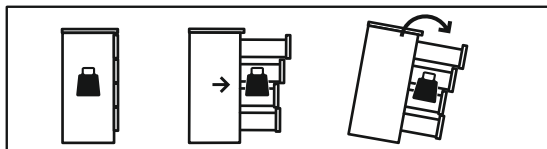

RU

ВНИМАНИЕ!

Опрокидывание мебели может стать причиной получения серьезных травм и привести к смерти.

Чтобы предотвратить опрокидывание, **ВСЕГДА** крепите мебель к стене с помощью фурнитуры, предотвращающей опрокидывание.

Вложенный дюбель используется для кирпичных и бетонных стен. Для крепления к стене используйте крепёж, подходящий для материала стен вашего дома, если вы не уверены какой тип крепления подходит для материала стен, обратитесь к специалисту или в специализированный магазин.

В конечном итоге ответственность за крепёж несёт специалист, осуществляющий монтаж.

В целях принятия мер дополнительной безопасности для предотвращения опрокидывания:

- Храните тяжелые предметы в нижнем ящике.
- Не ставьте тяжелые предметы сверху.
- Никогда не позволяйте детям залезать на ящики, дверцы или полки, а также виснуть на них.
- Используйте мебель по своему прямому назначению.

PL

OSTRZEŻENIE!

Przewrócenie się mebla może spowodować poważne lub śmiertelne obrażenia ciała na skutek przygniecenia.

ZAWSZE przymocuj ten mebel do ściany za pomocą ograniczników.

Kołek osadzony stosuje się do ścian z cegły i betonu. Do montażu na ścianie użyj łączników odpowiednich do materiału, z którego wykonana jest ściana, jeśli nie masz pewności, który rodzaj mocowania jest odpowiedni dla materiału ściennego, skontaktuj się ze specjalistą lub specjalistycznym sklepem. Ostatecznie za elementy złączne odpowiedzialny jest instalator.

Aby dodatkowo ograniczyć ryzyko poważnych obrażeń ciała i śmierci na skutek przewrócenia się mebla:

- Najcięższe przedmioty umieść w dolnej szufladzie.
- Nie kładź na wierzchu ciężkich przedmiotów.
- Nigdy nie pozwalaj dzieciom wspinać się na szuflady, drzwiczki lub półki.
- Używaj mebli zgodnie z ich przeznaczeniem.

EN

WARNING!

Serious or fatal crushing injuries can occur from furniture tip-over.

ALWAYS secure this furniture to the wall using tip-over restraints.

The embedded dowel is used for brick and concrete walls. For wall mounting, use fasteners suitable for the wall material of your home, if you are not sure which type of fastening is suitable for the wall material, contact a specialist or a specialized store. Ultimately, the installer is responsible for the fasteners.

To further reduce the risk of serious injury and death from tip-overs:

- Place heaviest items in the lower drawer.
- Do not leave objects on top of this product.
- Never let children climb or hang on drawers, doors, or shelves.
- Use the furniture for its intended purpose.